

ATWOOD WATER HEATER PARTS

PARTS QUICK REFERENCE

Q

In Section Q:	Atwood	Coleman (RVP)	Cooling Units	Dometic	Norcold	Powerhouse	Suburban	Thetford	Wedgewood	X-Reference
----------------------	--------	---------------	---------------	---------	---------	------------	----------	----------	-----------	-------------

Insulation Blanket
Fiberboard Jacket
Ring and Gasket Kit
Inner Tank

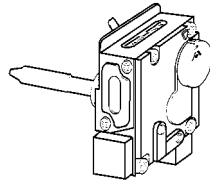
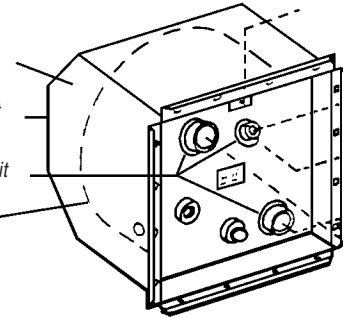

Gas Valve: Jade

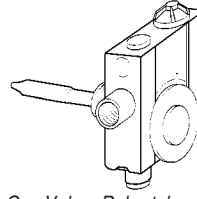

Gas Valve: Robertshaw

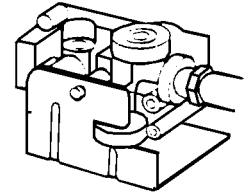

Gas Valve: DSI

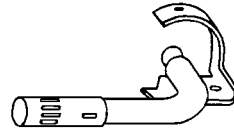

Main Burner



Burner Orifice



Orifice Holder

ATWOOD 6-GALLON GAS AND DIRECT IGNITION MODELS

PART DESCRIPTION	COAST ORDER NUMBER	G4SM	G6-A	G6A-1	G6A-2	G6A-3	G6A-6	G6A-7	G6A-2E	G6A-3E	G6A-4E	G6A-6E	G6A-7E	G6A-8E	G6A-6P	G6A-7P	G610	G610-B	G610-3	G610-3B	G610-3E	GH6	GH6-E	GH6-3	GH6-3E	GH6-4E	GH6-6	GH6-7	GH6-6E	GH6-7E	GH6-8E	GH610-3	GH610-3E					
		INNER TANKS:																																				
Inner Tank	NLA		•	•		•			•	•						•	•	•	•	•	•	•	•	•	•	•	•	•	•	•	•	•	•	•	•			
Inner Tank (S/O 91414)	S/O	•																																				
Inner Tank (S/O 91411)	S/O																								•			•	•									
Inner Tank	60280				•	•	•	•							•	•																						
Inner Tank	62500										•	•	•	•																								
Inner Tank (S/O 91642)	S/O																								•					•	•							
TANK INSTALLATION:																																						
Fiberboard Jacket (S/O 91174)	S/O	•				•	•	•	•	•	•	•	•	•	•	•				•	•			•	•	•	•	•	•	•	•	•	•	•	•	•		
Insulation Blanket	NLA	•	•	•	•	•	•	•	•	•	•	•	•	•	•	•	•	•	•	•	•	•	•	•	•	•	•	•	•	•	•	•	•	•	•	•		
Ring and Gasket Kit	65775	•	•	•	•	•	•	•	•	•	•	•	•	•	•	•	•	•	•	•	•	•	•	•	•	•	•	•	•	•	•	•	•	•	•	•		
GAS VALVES:																																						
Jade 1/4" FPT x 3/8" FPT (note: for use on older water heaters, 67550 45° fitting also needed)	60288	•				•	•	•							•	•				•	•		•	•			•	•								•		
Robertshaw 3/8" FPT x 3/8" FPT	60282	•	•	•	•	•	•	•							•	•	•	•	•	•	•	•	•	•	•	•	•	•	•	•	•	•	•	•	•	•		
Robertshaw 3/8 Invert x 3/8 FPT	60146		•	•	•												•	•																				
DSI 6 & 10 Gallon	65555								•	•	•	•	•	•								•	•	•	•	•	•	•	•	•	•	•	•	•	•	•	•	
MAIN BURNERS:																																						
Main Burner	NLA																	•	•	•	•	•	•	•	•	•	•	•	•	•	•	•	•	•	•	•	•	
Main Burner	60291	•	•	•	•	•	•	•	•	•	•	•	•	•	•	•	•	•	•	•	•	•	•	•	•	•	•	•	•	•	•	•	•	•	•	•	•	•
Main Burner	65776										•	•	•	•	•	•	•	•	•	•	•	•	•	•	•	•	•	•	•	•	•	•	•	•	•	•	•	•
BURNER ORIFICE:																																						
Burner Orifice	NLA																	•	•																			
Burner Orifice (S/O 92742)	S/O	•	•	•	•	•	•	•	•	•	•	•	•	•	•	•	•	•	•	•	•	•	•	•	•	•	•	•	•	•	•	•	•	•	•	•	•	•
Burner Orifice	NLA																			•	•	•	•	•	•	•	•	•	•	•	•	•	•	•	•	•	•	•
Orifice Elbow	NLA	•	•	•	•	•	•	•							•	•	•	•	•	•	•	•	•	•	•	•	•	•	•	•	•	•	•	•	•	•	•	•
Orifice Holder (S/O 91563)	S/O								•	•	•	•	•	•	•	•	•	•	•	•	•	•	•	•	•	•	•	•	•	•	•	•	•	•	•	•	•	•
PILOT ASSEMBLY:																																						
Jade Pilot Assembly	60287	•	•	•	•	•	•	•							•	•	•	•	•	•	•	•	•	•	•	•	•	•	•	•	•	•	•	•	•	•	•	•
Thermocouple	50216	•	•	•	•	•	•	•							•	•	•	•	•	•	•	•	•	•	•	•	•	•	•	•	•	•	•	•	•	•	•	•

Q PARTS QUICK REFERENCE

ATWOOD WATER HEATER PARTS

In Section Q: Atwood Coleman (RVP) Cooling Units Dometic Norcold Powerhouse Suburban Thetford Wedgewood X-Reference

ATWOOD 6-GALLON GAS AND DIRECT IGNITION MODELS

PART DESCRIPTION	COAST ORDER NUMBER	G4SM	G6-A	G6A-1	G6A-2	G6A-3	G6A-6	G6A-7	G6A-2E	G6A-3E	G6A-4E	G6A-6E	G6A-7E	G6A-8E	G6A-6P	G6A-7P	G610	G610-B	G610-3	G610-3B	G610-3E	GH6	GH6-E	GH6-3	GH6-3E	GH6-4E	GH6-6	GH6-7	GH6-6E	GH6-7E	GH6-8E	GH610-3	GH610-3E			
		CIRCUIT BOARDS:																																		
DSI Old Style	65630								•	•	•	•									•		•		•									•		
DSI New Style	63873												•	•																		•	•			
Ignitor Module <i>LS US only</i>	64295															•	•																			
Pilot Relighter Kit	60894	•	•	•	•	•	•	•							•	•	•	•	•	•		•		•				•	•					•		
ELECTRODES:																																				
2-Prong New Style	63874												•	•																		•	•			
1-Prong Re-ignitor (S/O 93804)	S/O							•							•	•												•								
THERMOSTATS:																																				
Front Mount 140° w/ECO	61332								•	•	•	•	•	•												•	•			•	•	•				
Front Mount 120°	63863								•	•	•	•	•	•												•	•			•	•	•				
Front Mount Adjustable	65421								•	•	•	•	•	•												•	•			•	•	•				
Rear Mount 140° (S/O 91952)	S/O					•																•		•											•	
ECO Switch - Manual Reset (S/O 92942)	S/O					•																•		•											•	
Thermostat/ECO Assembly (S/O 90037)	S/O					•																•		•											•	
THERMAL CUT-OFF:																																				
Thermal Cut-Off	63875												•	•																			•	•		
RELIEF VALVE:																																				
1/2" MPT	60278	•	•	•	•	•	•	•	•	•	•	•	•	•	•	•	•	•	•	•	•	•	•	•	•	•	•	•	•	•	•	•	•	•	•	•
DRAIN PLUGS:																																				
1/8" MPT (S/O 90-2)	S/O	•	•	•	•	•	•	•	•	•					•																				•	•
1/2" Plastic, Cd/2	60292	•	•	•	•	•	•	•	•	•	•	•	•	•	•	•	•	•	•	•	•	•	•	•	•	•	•	•	•	•	•	•	•	•	•	•
ACCESS COVER:																																				
6-Gal. with Grill, Colonial White	60289	•	•	•	•	•	•	•	•	•	•	•	•	•	•	•	•	•	•	•	•	•	•	•	•	•	•	•	•	•	•	•	•	•	•	•
6-Gal. with Grill, White	64442	•	•	•	•	•	•	•	•	•	•	•	•	•	•	•	•	•	•	•	•	•	•	•	•	•	•	•	•	•	•	•	•	•	•	•
DOOR HARDWARE KIT:																																				
Hardware Kit	60893	•	•	•	•	•	•	•	•	•	•	•	•	•	•	•	•	•	•	•	•	•	•	•	•	•	•	•	•	•	•	•	•	•	•	•
CAM-LOCK FASTENERS:																																				
Metal Cam-Lock, Cd/2	67257	•	•	•	•	•	•	•	•	•	•	•	•	•	•	•	•	•	•	•	•	•	•	•	•	•	•	•	•	•	•	•	•	•	•	•
SWITCH PACKAGE:																																				
DSI	60830								•	•	•	•	•	•								•		•		•										•

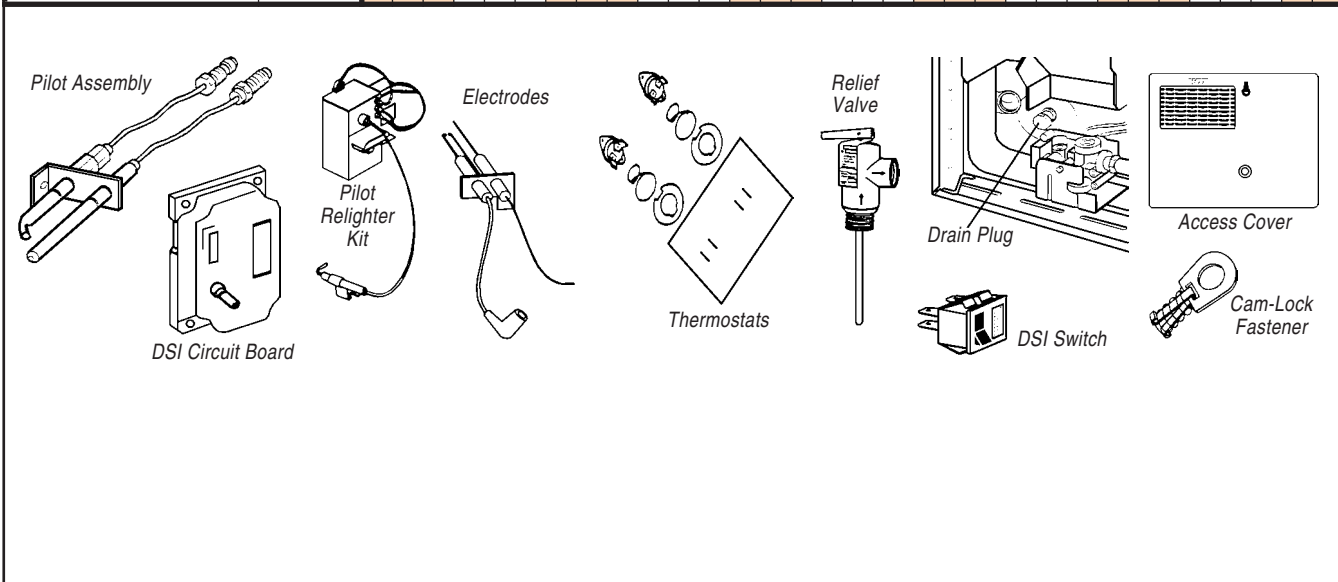

ATWOOD WATER HEATER PARTS

PARTS QUICK REFERENCE

Q

In Section Q: Atwood Coleman (RVP) Cooling Units Dometic Norcold Powerhouse Suburban Thetford Wedgewood X-Reference

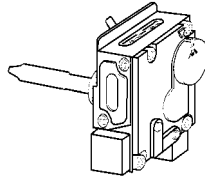
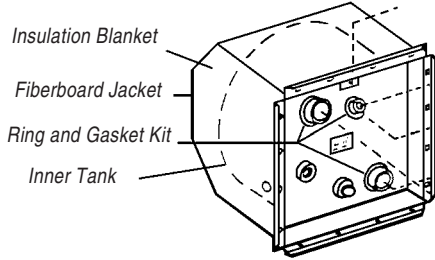

Gas Valve: Jade

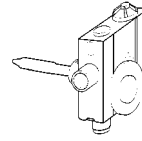

Gas Valve: Robertshaw

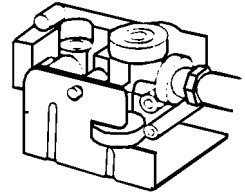

Gas Valve: DSI

ATWOOD 6-GAL. GAS AND DIRECT IGNITION • 6 GAL. COMBO

PART DESCRIPTION	COAST ORDER NUMBER	GC6-A	GC6A-3	GC6A-6	GC6A-7	GC6A-7E	GC6A-8	GC6A-8E	GC6AA-7	GC6AA-7E	GC6AA-8	GC6AA-8E	GC6AA-9E	GC6AA-10E	GCH6-4E	GCH6-6E	GCH6-7E	GCH6-8E	GCH6A-7E	GCH6A-9E
		INNER TANKS:																		
Inner Tank (Mfr#91591)	62360	•	•	•					•		•									
Inner Tank (Mfr#91059)	66575													•						
Inner Tank (Mfr#91592)	62361							•	•						•	•	•	•	•	•
Inner Tank (Mfr#91593)	62363					•		•		•		•	•		•	•	•		•	•
TANK INSTALLATION:																				
Fiberboard Jacket (6-gal.) (S/O 91174)	S/O		•	•	•	•	•	•	•	•	•	•	•	•	•	•	•	•	•	•
Insulation Blanket (6-gal.)	NLA	•	•	•	•	•	•	•	•	•	•	•	•	•	•	•	•	•	•	•
Ring and Gasket Kit	65775	•	•	•	•	•	•	•	•	•	•	•	•	•	•	•	•	•	•	•
GAS VALVES:																				
Jade 1/4" FPT x 3/8" FPT (note: for use on older water heaters, 67550 45° fitting also needed)	60288		•	•	•		•		•		•									
Robertshaw 3/8" FPT x 3/8" FPT	60282	•	•	•																
Robertshaw 3/8" Invert. x 3/8" FPT	60146	•																		
DSI 6 & 10 Gallon	65555					•	•	•	•	•	•	•	•	•	•	•	•	•	•	•
MAIN BURNERS:																				
Main Burners	60291	•	•	•	•		•		•		•									
Main Burners	65776					•		•		•		•	•		•	•	•	•	•	•
BURNER ORIFICE:																				
Burner Orifice (S/O 92742)	S/O	•	•	•	•	•	•	•	•	•	•	•	•	•	•	•	•	•	•	•
Orifice Elbow	NLA	•	•	•	•		•		•											
Orifice Holder (S/O 91563)	S/O					•		•		•		•	•		•	•	•	•	•	•
PILOT ASSEMBLY:																				
Jade	60287	•	•	•	•		•		•		•									
Thermocouple	50216	•	•	•	•		•		•		•									
CIRCUIT BOARDS:																				
DSI Old Style	65630													•	•					
DSI New Style	63873					•				•								•	•	•
Pilot Relighter Kit	60894	•	•	•	•		•		•		•									
ELECTRODES:																				
2-Prong New Style	63874					•		•		•		•						•	•	•

Q

PARTS QUICK REFERENCE

ATWOOD WATER HEATER PARTS

In Section Q: Atwood Coleman (RVP) Cooling Units Dometic Norcold Powerhouse Suburban Thetford Wedgewood X-Reference

ATWOOD 6-GAL. GAS AND DIRECT IGNITION • 6 GAL. COMBO

PART DESCRIPTION	COAST ORDER NUMBER	Model Variants																				
		GC6-A	GC6A-3	GC6A-6	GC6A-7	GC6A-7E	GC6A-8	GC6A-8E	GC6AA-7	GC6AA-7E	GC6AA-8	GC6AA-8E	GC6AA-9E	GC6AA-10E	GCH6-4E	GCH6-6E	GCH6-7E	GCH6-8E	GCH6A-7E	GCH6A-9E		
THERMOSTATS:																						
Front Mount 140° w/ECO	61332					•		•		•		•	•		•	•	•	•	•	•	•	•
Front Mount 120°	63863					•		•		•		•	•		•	•	•	•	•	•	•	•
Front Mount Adjustable	65421					•		•		•		•	•		•	•	•	•	•	•	•	•
Rear Mount 110VThermo/ECO (S/O 91853)	S/O	•	•	•	•	•	•	•						•	•	•	•					
Rear Mount 110V Thermo/ECO kit	67573											•	•	•	•						•	•
ON/OFF Switch 110V (S/O 92857)	S/O	•	•	•	•	•	•	•	•	•	•	•	•		•	•	•	•	•	•	•	•
THERMAL CUTOFF:																						
Thermal Cutoff	63875											•	•					•			•	•
HEAT ELEMENT:																						
120Volts/1400 Watts 4 Bolt; flanged	67477	•	•	•	•	•		•							•	•	•	•				
120Volts/1400 Watts Screw-In (Kit with Gasket)	67602											•	•	•	•	•					•	•
RELIEF VALVE:																						
1/2" MPT	60278	•	•	•	•	•	•	•	•	•	•	•	•		•	•	•	•	•	•	•	•
DRAIN PLUGS:																						
1/8" MPT (Iron) (S/O 90-2)	S/O	•	•	•	•			•														
1/2" Plastic, Cd/2	60292	•	•	•	•	•	•	•	•	•	•	•	•		•	•	•	•	•	•	•	•
ACCESS COVER:																						
6-Gallon with Grill, Colonial White	60289	•	•	•	•	•	•	•	•	•	•	•	•		•	•	•	•	•	•	•	•
6-Gallon with Grill, White	64442	•	•	•	•	•	•	•	•	•	•	•	•		•	•	•	•	•	•	•	•
DOOR HARDWARE KIT:																						
Door Hardware Kit	60893	•	•	•	•	•	•	•	•	•	•	•	•		•	•	•	•	•	•	•	•
CAM-LOCK FASTENERS:																						
Metal Fasteners, CD/2	67257	•	•	•	•	•	•	•	•	•	•	•	•		•	•	•	•	•	•	•	•
SWITCH PACKAGE:																						
DSI	60830																					

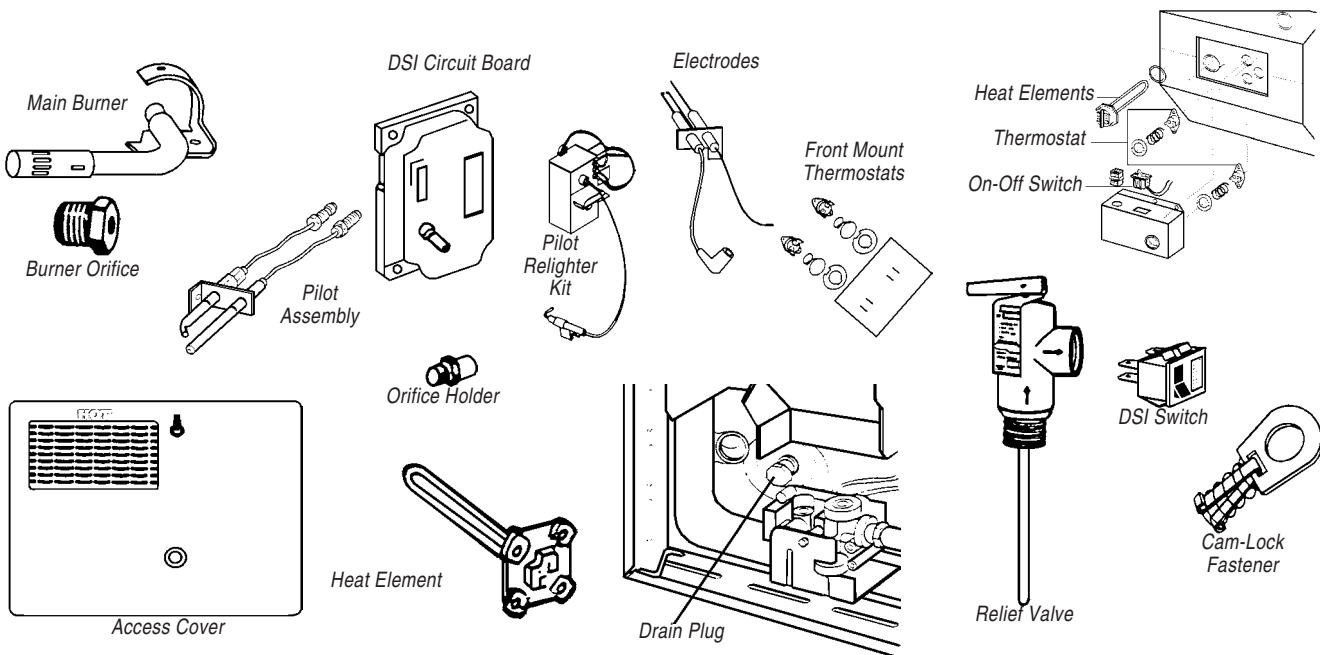

ATWOOD WATER HEATER PARTS

PARTS QUICK REFERENCE

Q

In Section Q: Atwood Coleman (RVP) Cooling Units Dometic Norcold Powerhouse Suburban Thetford Wedgewood X-Reference

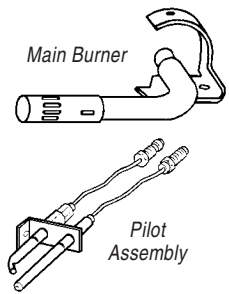
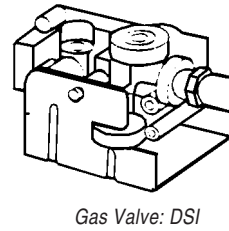
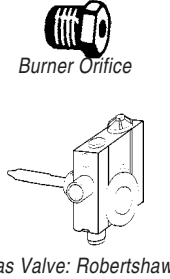
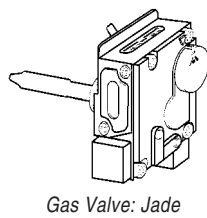
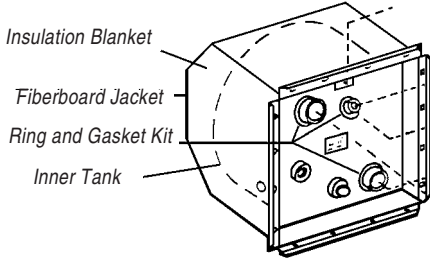

ATWOOD 10-GAL. GAS AND DIRECT IGNITION • 10 GAL. COMBO

PART DESCRIPTION	COAST ORDER NUMBER	G10-1	G10-1E	G10-1P	G10-2E	G10-2P	G10-3E	G10-B	G10-C	GC10-1	GC10-1E	GC10-2	GC10-2E	GC10-2P	GC10-3E	GC10-C	GC10A-2	GC10A-2E	GC10A-2P	GC10A-3E	GCH10-2E	GCH10A-2E	GCH10A-3E	GHT10-3E
		INNER TANKS:	NLA																					
Inner Tank	NLA																							
Inner Tank (S/O 94205)	S/O	•		•		•	•					•												
Inner Tank (S/O 93950)	S/O		•		•																			
Inner Tank (S/O 91596)	S/O																•		•					
Inner Tank (S/O 94200)	S/O									•				•										
Inner Tank (S/O 93953)	S/O										•		•	•						•	•	•	•	
Inner Tank (S/O 91595)	S/O																•							
Inner Tank (S/O 93952)	S/O																						•	
TANK INSTALLATION:	NLA	•	•	•	•	•	•	•	•	•	•	•	•	•	•	•	•	•	•	•	•	•	•	•
Fiberboard Jacket (10 gal.)	NLA	•	•	•	•	•	•	•	•	•	•	•	•	•	•	•	•	•	•	•	•	•	•	•
Ring and Gasket Kit	65775	•	•	•	•	•	•	•	•	•	•	•	•	•	•	•	•	•	•	•	•	•	•	•
GAS VALVES:																								
Jade 1/4" FPT x 3/8" FPT (note: for use on older water heaters, 67750 45° fitting also needed)	60288	•		•		•				•		•		•			•		•					
Robertshaw 3/8" FPT x 3/8" FPT	60282							•	•							•								
Robertshaw 3/8" Invert. x 3/8" FPT	60146							•	•							•								
DSI 6 & 10 Gallon	65555		•		•		•				•		•		•		•		•		•	•	•	•
MAIN BURNERS:	60291							•	•								•							
Main Burners	65778	•	•	•	•	•	•			•	•	•	•	•	•		•	•	•	•	•	•	•	•
BURNER ORIFICE:	NLA							•	•								•							
Burner Orifice <i>LS (Elkhart only)</i>	67575	•	•	•	•	•	•			•	•	•	•	•	•		•	•	•	•	•	•	•	•
Orifice Elbow	NLA							•	•								•							
Orifice Holder (S/O 91563)	S/O	•	•	•	•	•	•			•	•	•	•	•	•		•	•	•	•	•	•	•	•
PILOT ASSEMBLY:	60287	•		•		•		•	•	•			•	•	•	•	•		•					
Thermocouple	50216	•		•		•		•	•	•			•	•	•	•	•		•					

ATWOOD 10-GAL. GAS AND DIRECT IGNITION • 10 GAL. COMBO

PART DESCRIPTION	COAST ORDER NUMBER	G10-1	G10-1E	G10-1P	G10-2E	G10-2P	G10-3E	G10-B	G10-C	GC10-1	GC10-1E	GC10-2	GC10-2E	GC10-2P	GC10-3E	GC10-C	GC10A-2	GC10A-2E	GC10A-2P	GC10A-3E	GCH10-2E	GCH10A-2E	GCH10A-3E	GH10-3E
CIRCUIT BOARDS:																								
DSI Old Style - Post	65630		•								•													
DSI New Style - Spade	63873				•		•						•		•			•		•	•	•	•	•
Ignitor Module <i>LS (Elkhart only)</i>	64295			•		•								•				•						
Pilot Relighter Kit	60894	•						•	•	•		•					•							
ELECTRODES:																								
2-Prong New Style	63874				•		•						•		•			•		•	•	•	•	•
1-Prong Re-ignitor (S/O 93804)	S/O			•		•								•				•						
THERMOSTATS:																								
Front Mount 140° w/ECO	61332		•		•		•						•		•			•		•	•	•	•	•
Front Mount 120°	63863		•		•		•						•		•			•		•	•	•	•	•
Front Mount Adjustable	65421		•		•		•						•		•			•		•	•	•	•	•
Rear Mount 110V Thermo/ECO (S/O 91853)	S/O																•							
Rear Mount 110V Thermo/ECO kit	67573														•		•	•	•	•		•	•	•
Rear Mount 110V/140° (S/O 92943)	S/O									•	•	•	•	•	•									
Rear Mount 110V ECO	NLA									•	•	•	•	•	•									
ON/OFF Switch 110V (S/O 92857)	S/O									•	•	•	•	•	•			•		•	•	•	•	•
THERMAL CUTOFF:																								
Thermal Cutoff	63875				•		•						•		•			•		•	•	•	•	•
HEAT ELEMENT:																								
120Volts/1500 Watts	67477									•	•	•	•	•	•							•	•	•
120Volts/1500 Watts Screw-In (kit with gasket)	67602														•		•	•	•	•		•	•	•
RELIEF VALVE:																								
1/2" MPT	60278	•	•	•	•	•	•	•	•	•	•	•	•	•	•	•	•	•	•	•	•	•	•	•
DRAIN PLUGS:																								
1/8" MPT (Iron) (S/O 90-2)	S/O							•	•								•							
1/2" Plastic, Cd/2	60292	•	•	•	•	•	•	•	•	•	•	•	•	•	•	•	•	•	•	•	•	•	•	•
ACCESS COVER:																								
10-Gallon with Grill, Colonial White (S/O 93993)	S/O	•	•	•	•	•	•	•	•	•	•	•	•	•	•	•	•	•	•	•	•	•	•	•
10-Gallon with Grill, White	64443	•	•	•	•	•	•	•	•	•	•	•	•	•	•	•	•	•	•	•	•	•	•	•
DOOR HARDWARE KIT:																								
DOOR HARDWARE KIT	60893	•	•	•	•	•	•	•	•	•	•	•	•	•	•	•	•	•	•	•	•	•	•	•
CAM-LOCK METAL FASTENERS, CD/2																								
CAM-LOCK METAL FASTENERS, CD/2	67257	•	•	•	•	•	•	•	•	•	•	•	•	•	•	•	•	•	•	•	•	•	•	•
SWITCH PACKAGE: DSI																								
SWITCH PACKAGE: DSI	60830	•		•		•					•		•		•			•		•	•	•	•	•

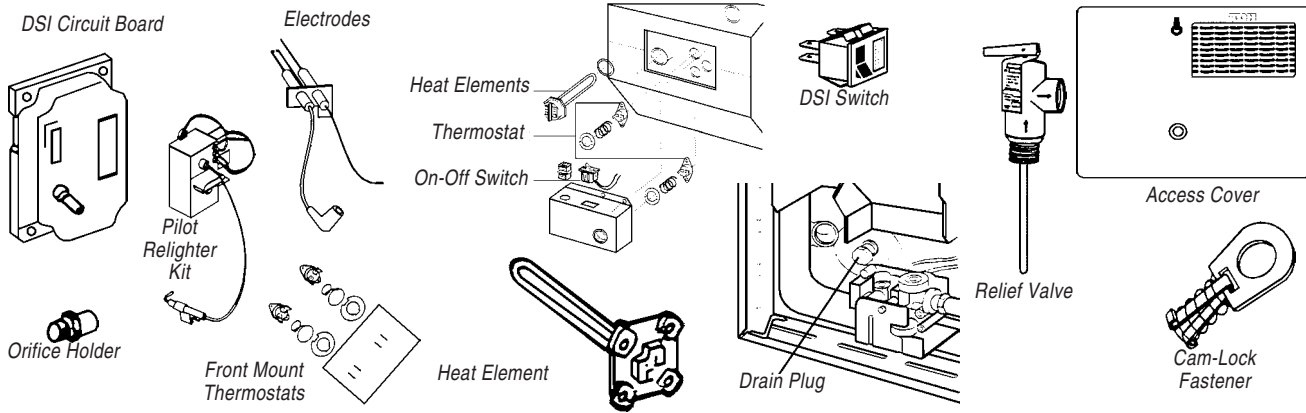

ATWOOD & HYDRO FLAME FURNACE PARTS

PARTS QUICK REFERENCE

Q

In Section Q: Atwood Coleman (RVP) Cooling Units Dometic Norcold Powerhouse Suburban Thetford Wedgewood X-Reference

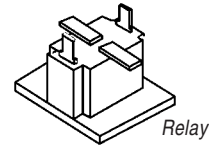
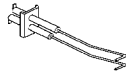
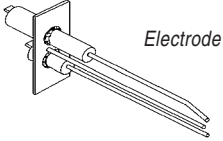
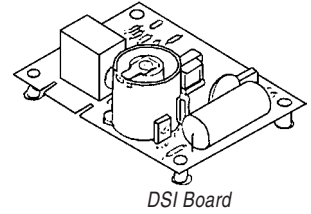
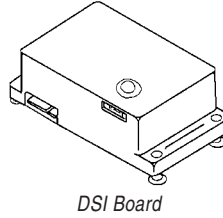
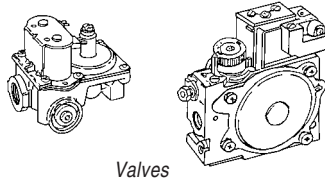
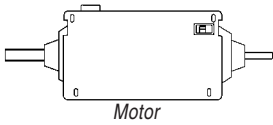

ATWOOD/HYDRO FLAME FURNACE PARTS

PART DESCRIPTION	COAST ORDER NUMBER	7912-II	7916, 20-II	8012-II	8516, 20-I	8516, 20-II	8516, 20-III	8516, 20-IV	8525-I	8525-II	8525-III	8525-IV	8531, 35-I	8531, 35-II	8531, 35-III	8531-IV	8535-IV	AC-82	AC-82N	AC89-I	AC89-II, III	DC82-25, 32	DC82-35, 41	DC89-I	DC89-II, III	FA-72D	FA-72P	FA-76D	FA-79D	FA-79P	FA-78-25, 32	FA78-35, 41	HF-80D	HF-80P			
		MOTORS:																																			
12 Volt Motor (S/O 31035)	S/O																																				
12 Volt Motor	66980	•	•																																		
12 Volt Motor(generic part)	S/O																																				
12 Volt Motor <i>LS (Visalia only)</i>	66949																																				
12 Volt Motor	61924																																				
12 Volt Motor	68543																																				
12 Volt Motor	68561																																				
12 Volt Motor (S/O 33219)	S/O																																				
12 Volt Motor	69673																																				
12 Volt Motor (S/O 37351)	S/O																																				
12 Volt Motor (S/O 37697)	S/O																																				
12 Volt Motor (S/O 37698)	S/O																																				
A.C. Motor (S/O 31039)	S/O																																				
A.C. Motor (S/O 35122)	S/O																																				
Motor	NLA																																				
Motor	61618																																				
Motor	NLA																																				
VALVES:																																					
White Rogers 25M16-701	68571																																				
White Rogers Coil (1 ea.)	68565	•	•	•	•	•	•	•	•	•	•	•	•	•	•	•	•	•	•	•	•	•	•	•	•	•	•	•	•	•	•	•	•	•	•	•	
White Rogers (S/O 36035)	S/O	•	•	•																																	
ITT Pilot Fit Kit (PILOT)	NLA																																				
ITT Pilot Retro Fit Kit (PILOT) (S/O 33716)	S/O																																				
ITT Pilot Retro Fit Kit (PILOT) (S/O 33717)	S/O																																				
ITT/Fenwal Retro Fit Kit (DSI) (S/O 33796)	S/O																																				
ITT/Fenwal Retro Fit Kit (DSI) (S/O 33797)	S/O																																				
ITT/Fenwal Retro Fit Kit (DSI) (S/O 33806)	S/O																																				

Q

PARTS QUICK REFERENCE

ATWOOD & HYDRO FLAME FURNACE PARTS

In Section Q: Atwood Coleman (RVP) Cooling Units Dometic Norcold Powerhouse Suburban Thetford Wedgewood X-Reference

ATWOOD/HYDRO FLAME FURNACE PARTS

PART DESCRIPTION	COAST ORDER NUMBER	7912-II	7916, 20-II	8012-II	8516, 20-I	8516, 20-II	8516, 20-III	8516, 20-IV	8525-I	8525-II	8525-III	8525-IV	8531, 35-I	8531, 35-II	8531, 35-III	8531-IV	8535-IV	AC-82	AC-82N	AC89-I	AC89-II, III	DC82-25, 32	DC82-35, 41	DC89-I	DC89-II, III	FA-72D	FA-72P	FA-76D	FA-79D	FA-79P	FA-78-25, 32	FA-78-35, 41	HF-80D	HF-80P				
		DSI BOARDS:																																				
DSI Board A.C.	68537																																					
DSI Board with blower control	65285	•	•	•	•	•	•	•	•	•	•	•	•	•	•	•	•	•	•	•	•	•	•	•	•	•	•	•	•	•	•	•	•	•	•	•		
ELECTRODES:																																						
Electrode PSE (S/O 33235)	S/O																																					
Electrode	69689				•					•				•																								
Electrode	NLA					•					•				•																							
Electrode (S/O 33234)	S/O						•																					•	•								•	
Electrode (S/O 34001)	S/O																					•			•													
Electrode - Single Sense (S/O 37057)	S/O							•				•					•	•																				
Electrode - Dual Sense (36997)	S/O																						•			•												
RELAY:																																						
Klixon Relay	66964	•	•	•	•	•	•	•	•	•	•	•	•	•	•	•	•	•	•	•	•	•	•	•	•	•	•	•	•	•	•	•	•	•	•	•	•	
SAIL SWITCHES:																																						
Sail Switch (S/O 35282)	S/O				•				•					•																								
Sail Switch	NLA																				•	•		•	•									•	•			
Sail Switch	NLA																				•	•		•	•													
Sail Switch	NLA																																					
Sail Switch (S/O 32467)	S/O																				•	•		•	•													
Sail Switch (S/O 35054)	S/O																																					
Sail Switch (S/O 35050)	S/O																																					
Sail Switch (S/O 36133)	S/O	•	•																																			
LIMIT SWITCHES:																																						
Manual Reset	NLA																																					
On/Off Switch (S/O 36121)	S/O																																					
Limit Switch	64610	•	•	•																																		
Limit Switch	64611																																					
Limit Switch 130°	69678																																					
Limit Switch 170° LS (Visalia only)	66958																																					
Limit Switch 190° (S/O 31025)	S/O																																					
Limit Switch 190°	68570																																					
Limit Switch 190° (S/O 36176)	S/O																																					
BURNER HEADS:																																						
Burner	NLA																																					
Burner (S/O 33842)	S/O																																					
Burner	61608	•		•																																		
Burner	68567																																					
Burner	NLA																																					
Burner	NLA																																					
Burner (S/O 32846)	S/O																																					
Burner (S/O 34791)	S/O																																					

