

NORCOLD REFRIGERATOR PARTS

PARTS QUICK REFERENCE

Q

In Section Q: Atwood Coleman (RVP) Cooling Units Dometic Norcold Powerhouse Suburban Thetford Wedgewood X-Reference

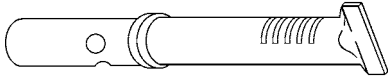

Horizontal Burner

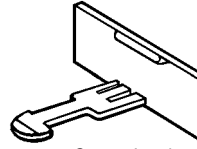

Center Latch

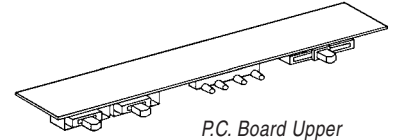

P.C. Board Upper



Door Handle

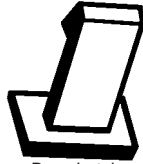

Door Latch



Electrode, Spark/Sense

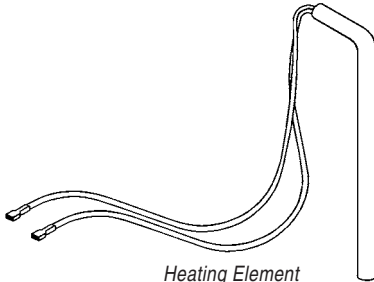

Heating Element

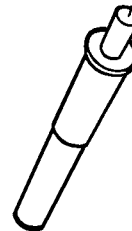

Piezo Igniter

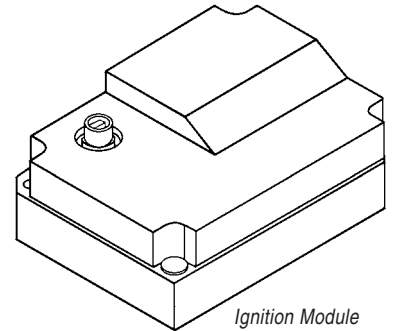

Ignition Module

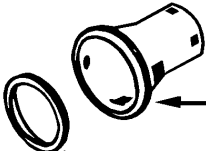

Orifice

Copper Gasket

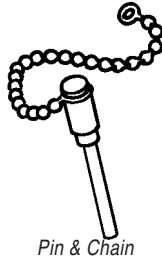

Pin & Chain

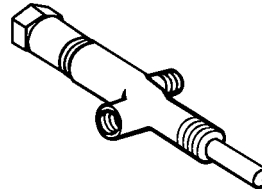

Safety Valve



Rocker Switch

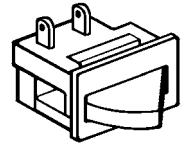

Light Switch

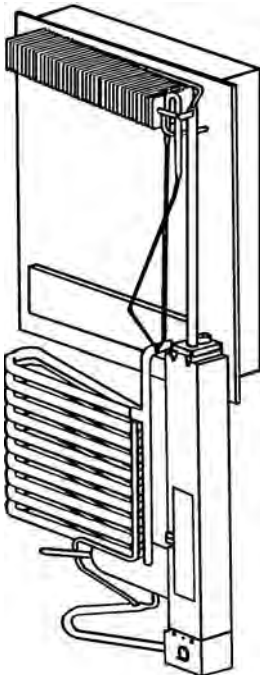

Cooling Unit

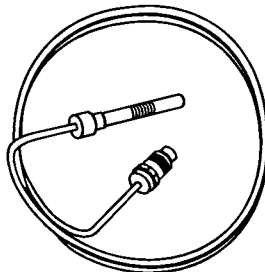

Thermocouple

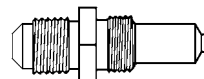

Orifice w/Adapter

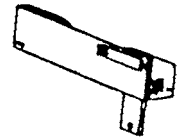

Door Latch, 900 Series

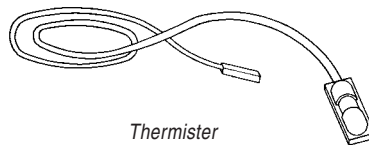

Thermister

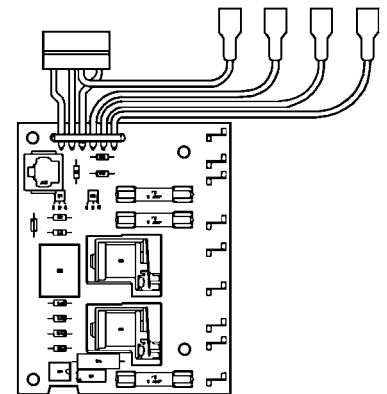

Power Supply Board

Q

PARTS QUICK REFERENCE

NORCOLD REFRIGERATOR PARTS

In Section Q: Atwood Coleman (RVP) Cooling Units Dometic Norcold Powerhouse Suburban Thetford Wedgewood X-Reference

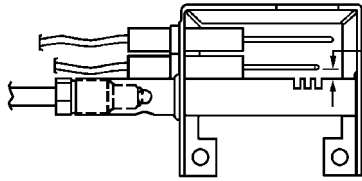

Horizontal Burner with Sense Electrode

Denotes Limited Supply

MODELS WITH HORIZONTAL BURNER COOLING UNITS

PART DESCRIPTION	ORDER # FOR O.E.M. PART	GENERIC PART* ORDER #	322	323	442	443	452	453	462	463	482	483	652	653	662	663	682	683	874 EG2	874 EG3	875 EG2	875 EG3	876 EG2	876 EG3	878 EG2	878 EG3
COOLING UNITS:																										
Cooling Unit, w/Cabinet	S/O 61748138		•	•																						
Cooling Unit (S/O 61687040)	S/O	S/O CU619			•	•																				
Cooling Unit 61687140	62761						•	•					•	•							•	•				
Cooling Unit (S/O 61687240)	S/O	60706							•	•					•	•							•	•		
Cooling Unit (S/O 61687340)	S/O	60704									•	•					•	•							•	•
Cooling Unit (S/O 61614637)	S/O	S/O CU619																	•	•						
ELEMENTS Watts/Volts:																										
Heat Element 140W/110V	S/O 61745322		•	•																						
Heat Element 140W/12V (S/O 61745422)	S/O			•																						
Heat Element 200W/110V (61562522)	S/O				•	•	•	•					•	•					•	•	•	•				
Heat Element 300W/110V	62557								•	•	•	•			•	•	•	•					•	•	•	•
Heat Element 150W/14V (S/O 61562622)	S/O				•			•						•						•						
Heat Element 225W/14V (S/O 61562822)	S/O									•		•				•		•						•		•
THERMOSTATS:																										
Gas Control (S/O 61752922)	S/O		•	•																						
Electric (S/O 61756722)	S/O		•	•																						
Gas/Electric (S/O 617994)	S/O																									
Gas/Electric (Sourdillon) (S/O 6160842)	S/O				•	•	•	•	•	•	•	•							•	•	•	•				
THERMISTERS:																										
Thermister 66" without clip	S/O 61693822												•	•	•	•	•	•					•	•	•	•
Thermister 78" without clip (S/O 6169782)	S/O																						•	•	•	•
Clip only (S/O 61689122)	S/O												•	•	•	•	•	•					•	•	•	•
PIEZO IGNITOR:																										
Piezo Ignitor (S/O 61645622)	S/O		•	•																						
IGNITION MODULE:																										
Relighter w/ground wire (S/O 61746122)	S/O				•	•	•	•	•	•	•	•							•	•	•	•				
Ignition Control Module (S/O 616972)	S/O												•	•	•	•	•	•					•	•	•	•
CIRCUIT BOARDS:																										
Interface Board (2-way)	(2)												•	•	•	•	•									
Interface Board (3-way)	(2)													•				•								
Eyebrow Board	(2)												•	•	•	•	•	•								
PC Board (2-way)	NLA																						•		•	
PC Board (3-way)	NLA	S/O 61602822																						•		•
SWITCHES, EYEBROW:																										
Switch, Black 3-Position	S/O 61525922	64334													•	•	•	•								
Interrupter 621737	67490		•	•																						
SWITCHES, DIVIDER:																										
Switch, Light (S/O 61581022)	S/O								•	•	•	•			•	•	•	•					•	•	•	•
Switch, Black 2-position	NLA																									
Switch, Black 3-Position	S/O 61525922	64334							•	•	•	•					•	•					•	•	•	•
Rocker Switch, Black (S/O 61594322)	S/O												•	•	•	•										

*NOTE: The use of generic parts for warranty repairs will void the manufacturer's warranty. Coast Generic Parts are warranted for one year, except Circuit Boards, which are covered for 90 days. **(2) CONTACT NORCOLD SERVICE**

NORCOLD REFRIGERATOR PARTS

PARTS QUICK REFERENCE

Q

In Section Q:	Atwood	Coleman (RVP)	Cooling Units	Dometic	Norcold	Powerhouse	Suburban	Thetford	Wedgewood	X-Reference
----------------------	--------	---------------	---------------	---------	---------	------------	----------	----------	-----------	-------------

MODELS WITH HORIZONTAL BURNER COOLING UNITS

PART DESCRIPTION	ORDER # FOR O.E.M. PART	GENERIC PART* ORDER #	322	323	442	443	452	453	462	463	482	483	652	653	662	663	682	683	874 EG2	874 EG3	875 EG2	875 EG3	876 EG2	876 EG3	878 EG2	878 EG3
			SWITCHES, BASE: Selector Switch (S/O 61722422)	S/O		•	•																			
Switch, Ignition	62758						•	•	•	•	•	•														
Switch, 3-Way (S/O 61694822)	S/O				•		•		•		•										•		•			
Switch, Rocker (S/O 61594322)	S/O																		•	•	•	•				
THERMOCOUPLES: Thermocouple (S/O 61723122)	S/O		•	•																						
Thermocouple (S/O 61436322)	S/O				•	•	•	•	•	•	•	•								•	•	•	•			
Thermocouple (S/O 618445)	S/O		•	•																						
SAFETY VALVES: Safety Valve (S/O 61752922)	S/O		•	•																						
SOLENOID VALVES: Solenoid Valve (ASCO) (S/O 61551822)	S/O												•	•	•	•	•	•						•	•	•
BURNER ASSEMBLIES: Burner Assembly (S/O 61755422)	S/O		•	•																						
Burner Assembly (5-slot) (S/O 61705222)	S/O				•	•	•	•	•	•	•	•	•	•	•	•	•	•	•	•	•	•	•	•	•	•
ORIFICES: Orifice, w/Adapter (S/O 61753137)	S/O		•	•																						
Orifice (0.14) without gasket (S/O 618866)	S/O				•	•	•	•					•	•						•	•	•	•			
Orifice (0.16) without gasket (S/O 628003)	S/O								•	•	•	•			•	•	•	•					•	•	•	•
Gasket only (For 68146 and 68141)	62772				•	•	•	•	•	•	•	•	•	•	•	•	•	•	•	•	•	•	•	•	•	•
ELECTRODES: Electrode (S/O 61722922)	S/O		•	•																						
Electrode, Spark/Sence (1/4")	62768				•	•	•	•	•	•	•	•	•	•	•	•	•	•								
Electrode, Spark (S/O 619153)	S/O																									
Electrode Assy. (1/8") (S/O 61607822)	S/O				•	•	•	•	•	•	•	•								•	•	•	•			
Ignition Electrode (S/O 61524722)	S/O																						•	•	•	•
Sensor Electrode (S/O 61524822)	S/O																						•	•	•	•
MISCELLANEOUS: Travel Latch (S/O 61719630)	S/O		•	•																						
Pin and Chain	46177																			•	•	•	•			
End Cap (Black) Spring Catch	62701				•	•	•	•	•	•	•	•	•	•	•	•	•	•	•							
End Cap (Black) Stop	62703				•	•	•	•	•	•	•	•	•	•	•	•	•	•	•							
Upper Door Handle Assy. (Blk) (S/O 61649038)	S/O								•	•	•	•														
Upper Door Handle Assy. (Blk) (S/O 61743638)	S/O														•	•	•	•								
Upper Door Handle Assy. (Brn) (S/O 61743637)	S/O														•	•	•	•								
Lower Door Handle Assy. (Blk) (S/O 61639638)	S/O			•	•																					
Lower Door Handle Assy. (Blk) (S/O 61648838)	S/O						•	•			•	•														
Lower Door Handle Assy. (Blk)	NLA								•	•																
Lower Door Handle Assy. (Blk) (S/O 61648838)	S/O			•	•						•	•	•	•	•	•	•	•								
Lower Door Handle Assy. (Brn) (S/O 61743537)	S/O												•	•			•	•								
Lower Door Handle Assy. (Brn) (S/O 61743737)	S/O														•	•										
Door Latch	62625		•	•	•	•	•	•	•	•	•	•	•	•	•	•	•	•								
Spring Holder, LH (S/O 619042)	S/O			•	•																					
Spring Holder, RH	64988			•	•																					

 Denotes Limited Supply

Q PARTS QUICK REFERENCE

NORCOLD REFRIGERATOR PARTS

In Section Q:	Atwood	Coleman (RVP)	Cooling Units	Dometic	Norcold	Powerhouse	Suburban	Thetford	Wedgewood	X-Reference
---------------	--------	---------------	---------------	---------	---------	------------	----------	----------	-----------	-------------

- 1** Depending on the Serial Number of the N611:
For Serial Numbers up to 9056491, use #62199001
For Serial Numbers above 9056491, use #628661
- 2** Will fit any N6 or N8 series:
For Serial Numbers below 9126825, use #632168001
For Serial Numbers above 9126825, use #628661

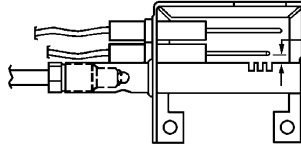

Horizontal Burner with Sense Electrode

Denotes Limited Supply

MODELS WITH HORIZONTAL BURNER COOLING UNITS

PART DESCRIPTION	ORDER # FOR O.E.M. PART	GENERIC PART* ORDER #	N260	N260.3	N300	N300.3	N400	N400.3	N500	N500.3	N611	N621	N641	N641-1M	N641-3	N821	N841	N841-1M	N841-3	1200-LR	1200-LR1M	1210
COOLING UNITS:																						
Cooling Unit (S/O 619091)	S/O		•	•																		
Cooling Unit (S/O 619088)	S/O				•	•																
Cooling Unit (S/O 621462)	S/O						•	•														
Cooling Unit (S/O 621427)	S/O								•	•												
Cooling Unit (S/O 618543)	S/O	64941									•	•	•	•	•							
Cooling Unit (S/O 618542)	S/O	64942														•	•	•	•			
Cooling Unit (S/O 634747)	S/O																			•	•	
Cooling Unit (S/O 634746)	S/O																					•
HEAT ELEMENTS:																						
Heat Element AC (S/O 61745322)	S/O		•	•																		
Heat Element DC/EG3 (S/O 61745422)	S/O			•																		
Heat Element 180W/120V (S/O 619063)	S/O				•	•																
Heat Element 165W/12V (S/O 619065)	S/O				•	•																
Heat Element 200W/110V (S/O 61562522)	S/O						•	•	•	•												
Heat Element DC/EG3 (S/O 620884)	S/O							•		•												
Heat Element 225W/14V (3-Way) (S/O 61562822)	S/O															•				•		
Heat Element 300W/110V	62557										•	•	•	•	•	•	•	•	•	•	•	
Heat Element 225W/110V	65060																			•	•	
THERMOSTATS:																						
Gas Valve/Tstat Control (S/O 617944)	S/O		•	•	•	•																
Tstat-DC Fan/Thermo Disc 618093	67453													•	•	•	•	•	•			
SELECTOR SWITCH																						
Selector Switch, 4-position (619168)	S/O		•	•	•	•																
GAS SOLENOID VALVE																						
Solenoid Valve (Asco) (61551822)	S/O										•	•	•	•	•	•	•	•	•	•	•	•
THERMISTERS:																						
Thermister/Lamp Wire Assembly	62477										•	•	•	•	•	•	•	•	•	•	•	•
Thermister/Lamp Wire Assembly	67479																					•
Thermister clip (S/O 61689122)	S/O																					
PIEZO IGNITOR:																						
Piezo Ignitor (S/O 61645622)	S/O		•	•	•	•	•	•														
IGNITION MODULE:																						
Ignition Module (620796)	S/O								•	•												
CIRCUIT BOARDS:																						
Power Board 628661 (1 serial # above 9056491)	67524										•	•	•				•					•
Power board/EG2 (Kit) (1 serial # up to 9056491)	66379										•	•										
Control Assy-Optical Blk 628979	67525										•											
Control Assy-Optical Blk 621988	67497										•											
Optical Control, (Black) 2-Way (633292)	69246												•	•	•		•	•	•			
Optical Control (629113)	S/O																					•
Kit-Power Board/EG2 632168001 (2 serial # up to 9126825)	68661																				•	•
Power Board (2-Way)	S/O											•				•						
Power Board (2-Way)	64664												•	•		•	•					
Power Board (3-Way) (621270)	S/O															•				•		
SVC Kit/Ctrl Assy/Pwr Bd/Gray (624869)	S/O																			•	•	
THERMOCOUPLES:																						
Thermocouple (S/O 618445)	S/O		•	•																		
Thermocouple (S/O 619154)	65068				•	•																
Thermocouple (S/O 620424)	S/O						•	•	•	•												

NORCOLD REFRIGERATOR PARTS

PARTS QUICK REFERENCE

Q

In Section Q:	Atwood	Coleman (RVP)	Cooling Units	Domestic	Norcold	Powerhouse	Suburban	Thetford	Wedgewood	X-Reference													
MODELS WITH HORIZONTAL BURNER COOLING UNITS																							
PART DESCRIPTION	ORDER # FOR O.E.M. PART	GENERIC PART* ORDER #	N260	N260.3	N300	N300.3	N400	N400.3	N500	N500.3	N611	N621	N641	N641-1M	N641-3	N821	N841	N841-1M	N841-3	1200-LR	1200-LR1M	1210	
SAFETY VALVE: Safety Valve (S/O 622746001)	S/O			•	•	•	•	•	•	•													
BURNER ASSEMBLY: Burner Assembly (621953)	S/O				•	•																	
Burner Assembly (5-Slot) (SO 61705222)	S/O							•	•	•	•	•	•	•	•	•	•	•	•	•			
ORIFICE: Burner/Orifice Adapter Kit (621649)	S/O		•	•																			
Burner/Orifice Adapter Kit (621951)	S/O				•	•																	
Jewel Orifices (.015 in)	65370												•	•	•	•	•	•	•	•			
Jewel Orifices (.0155 in)	65370																•	•	•	•			
Burner/Orifice Adapter Kit	65370											•	•	•	•	•	•	•	•	•			
Burner/Orifice Adapter Kit (621955)	S/O							•	•	•	•												
ELECTRODES: Electrode (S/O 61722922)	S/O		•	•																			
Electrode (620227)	S/O							•	•														
Electrode (S/O 619153)	S/O							•	•														
Electrode (61692222)	62768																						•
Electrode, Spark/Sence	62768																						
MISCELLANEOUS: Door Latch (619228)	S/O		•	•																			
Door Latch (619103)	S/O					•	•	•	•	•	•												
Door Liner Assy-Lower 8' (623942)	67503																	•					
Door Liner Assy-Lower 6' (623955)	67504													•									
Trim Piece Assy-Top/Blk 622319	67498													•				•					
Trim Piece Foam Tape 622323	67499													•				•					
Shelf-Wire/Cut Out 632450	67460											•	•				•						
Shelf-Wire/Full 632451	67475											•	•				•						
Freezer Wire Shelf (620250)	S/O											•	•	•	•	•	•	•	•	•			
Latch Plate, Door (619104)	S/O					•	•	•	•	•													
Handle Assy. (Black) top LH/ bottom RH (619865)	S/O											•	•	•	•	•	•	•	•	•			
Handle Assy. (Black) top RH/ bottom LH (619866)	S/O											•	•	•	•	•	•	•	•	•			
Handle Assy. (Black) top LH/ bottom RH (S/O 619573)	S/O																				•	•	
Handle Assy. (Black) top RH/ bottom LH (S/O 619574)	S/O																				•	•	
Hinge Pin-Upper/Black/SDL 623899	67501											•	•				•						
Hinge Bushing (2 per door) 619671	67457																	•					
Drip Tray/Louver-Inside 623250	67500													•				•					
Spring Holder Assembly, LH (S/O 619042)	S/O					•	•	•	•	•	•												
Spring Holder Assembly, RH (limited supply)	64988					•	•	•	•	•	•												
Kit-Ice Maker 633324	69244													•				•					•
Kit-Water Valve Sgl Port 633325	69245													•				•					
Lamp-DC Light Bulb 632545	68663													•	•	•	•	•	•				

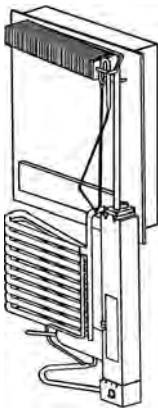

Cooling Unit

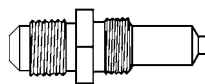

Orifice w/Adapter

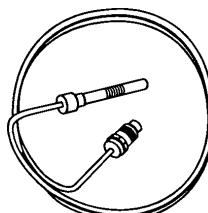

Thermocouple

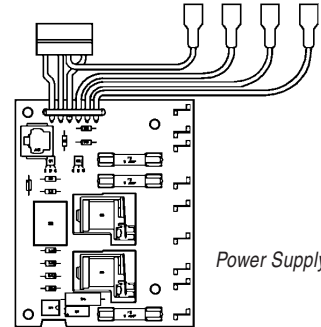

Power Supply Board

*NOTE: The use of generic parts for warranty repairs will void the manufacturer's warranty. Coast Generic Parts are warranted for one year, except Circuit Boards, which are covered for 90 days.

Q

PARTS QUICK REFERENCE

NORCOLD REFRIGERATOR PARTS

In Section Q: Atwood Coleman (RVP) Cooling Units Dometic Norcold Powerhouse Suburban Thetford Wedgewood X-Reference

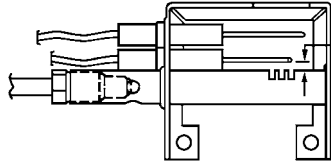

Horizontal Burner with Sense Electrode

Denotes Limited Supply

MODELS WITH HORIZONTAL BURNER COOLING UNITS

PART DESCRIPTION	ORDER # FOR O.E.M. PART	ORDER # FOR GENERIC PART*	6052	6053	6062	6063	6082	6083	6162	6163	6182	6183	8652	8653	8662	8663	8682	8683	962	963	982	983	9162	9163	9182	9183
			COOLING UNITS:																							
Cooling Unit	62761	S/O CU331	•	•									•	•												
Cooling Unit (S/O 61687240)	S/O	60706			•	•			•	•					•	•										
Cooling Unit (S/O 61687340)	S/O	60704					•	•			•	•					•	•								
Cooling Unit	NLA	64941																	•	•			•	•		
Cooling Unit (S/O 618542)	S/O	64942																			•	•			•	•
HEAT ELEMENTS Watts/Volts:																										
H/E 200W/110V (S/O 61562522)	S/O		•	•									•	•												
H/E 300W/110V (S/O 61692722)	S/O				•	•	•	•	•	•	•	•			•	•	•	•	•	•	•	•	•	•	•	•
H/E 150W/14V (S/O 61562622)	S/O			•										•												
H/E 225W/14V (S/O 61562822)	S/O					•				•						•	•		•		•		•		•	
THERMISTER:																										
Thermister 66" without clip (S/O 61693822)	S/O		•	•	•	•	•	•	•	•	•	•	•	•	•	•	•	•								
Clip only (S/O 61689122)	S/O		•	•	•	•	•	•	•	•	•	•	•	•	•	•	•	•								
Thermister/Lamp Wire Assy.	62477																		•	•	•	•	•	•	•	•
IGNITION MODULE:																										
Ignition Control Module (S/O OEM: NOR 61717037MC; GEN: NOR 616972MC) (1)	S/O		•	•	•	•	•	•	•	•	•	•	•	•	•	•	•	•								
CIRCUIT BOARDS:																										
PC Board (2-Way) Upper	NLA		•		•																					
PC Board (3-Way) Upper (S/O 61602822)	S/O			•		•		•																		
PC Board (2-Way) Upper	62752								•		•															
PC Board (3-Way) Upper	62754									•		•														
PC Board (2-Way) Upper	NLA												•		•		•									
PC Board (3-Way) Upper (S/O 61563922)	S/O													•		•		•								
Power Supply Board (2-Way)	62753	64871	•		•		•		•		•															
Power Supply Board (3-Way) (S/O 618666)	S/O			•		•		•		•		•														
Power Supply Board (2-Way) (6157112) (D-15711 2-Way)		S/O											•		•		•									
Power Supply Board (3-Way) (61565022)		65052												•		•		•								
CIRCUIT BOARDS: (900series)																										
Front Control Box Assy. (S/O 618245)	S/O																			•	•	•	•			
Front Control Box Assy. (S/O 618588)	S/O																						•	•	•	•
Power Supply Board (2-Way) (S/O 698198)	S/O																		•		•					
Controls Repl. Kit 2W(1fr.+1rear)	NLA																		•		•		•	•		
DC Module Board (S/O 618561)	S/O																		•	•	•	•	•	•	•	•

*NOTE: The use of generic parts for warranty repairs will void the manufacturer's warranty. Coast Generic Parts are warranted for one year, except Circuit Boards, which are covered for 90 days.

NORCOLD REFRIGERATOR PARTS

PARTS QUICK REFERENCE

Q

In Section Q:	Atwood	Coleman (RVP)	Cooling Units	Domestic	Norcold	Powerhouse	Suburban	Thetford	Wedgewood	X-Reference
---------------	--------	---------------	---------------	----------	---------	------------	----------	----------	-----------	-------------

MODELS WITH HORIZONTAL BURNER COOLING UNITS

PART DESCRIPTION	ORDER # FOR O.E.M. PART	ORDER # FOR GENERIC PART*	6052	6053	6062	6063	6082	6083	6162	6163	6182	6183	8652	8653	8662	8663	8682	8683	962	963	982	983	9162	9163	9182	9183	
SWITCHES, EYEBROW:																											
Switch, Black 3-Position (S/O 61525922)	S/O	64334			•	•	•	•	•	•	•	•															
SWITCHES, DIVIDER:																											
Switch, Light (S/O 61581022)	S/O				•	•	•	•	•	•	•	•			•	•	•	•									
Rocker Switch, Black (S/O 61594322)	S/O														•	•	•	•									
SOLENOID VALVES:																											
Solenoid Valve (ASCO) (S/O 61551822)	S/O		•	•	•	•	•	•	•	•	•	•	•	•	•	•	•	•	•	•	•	•	•	•	•	•	
BURNER ASSEMBLIES:																											
Burner Assembly (5-slot) (SO 61705222)	S/O		•	•	•	•	•	•	•	•	•	•	•	•	•	•	•	•	•	•	•	•	•	•	•	•	
ORIFICES:																											
Orifice (0.14) without gasket (S/O 618866)	S/O		•	•									•	•													
Orifice (0.16) without gasket (S/O 628003)	S/O				•	•	•	•	•	•	•	•			•	•	•	•	•	•	•	•	•	•	•	•	
Gasket only	62772		•	•	•	•	•	•	•	•	•	•	•	•	•	•	•	•	•	•	•	•	•	•	•	•	
ELECTRODES:																											
Electrode, Spark/Sence	62768		•	•	•	•	•	•	•	•	•	•							•	•	•	•	•	•	•	•	
Ignition Electrode (S/O 61524722)	S/O												•	•	•	•	•	•									
Sensor Electrode (S/O 61524822)	S/O												•	•	•	•	•	•									
MISCELLANEOUS:																											
End Cap (Black) Spring Catch - (Brown, NLA)	62701		•	•	•	•	•	•	•	•	•	•			•	•	•	•									
End Cap (Black) Stop - (Brown, NLA)	62703		•	•	•	•	•	•	•	•	•	•			•	•	•	•									
Spring, Door Handle	62555		•	•	•	•	•	•	•	•	•	•	•	•	•	•	•	•									
Upper Door Handle Assy.(Blk) (S/O 61649038)	S/O				•	•	•	•	•	•	•	•															
Upper Door Handle Assy.(Blk) (S/O 61592938)	S/O														•	•	•	•									
Upper Door Handle Assy. (Brown)	NLA														•	•	•	•									
Lower Door Handle Assy.(Blk) (S/O 61648838)	S/O		•	•			•	•			•	•	•			•	•										
Lower Door Handle Assy.(Blk) (S/O 61648938)	S/O				•	•			•	•																	
Lower Door Handle Assy.(Blk) (S/O 61593138)	S/O																•	•									
Lower Door Handle Assy.(Blk) (S/O 61593038) -	S/O														•	•											
Lower Door Handle Assy. (Brn)	NLA												•	•			•	•									
Foamed Lower Door & Gasket	62456																									•	•
Door Latch	62625				•	•	•	•	•	•	•	•	•	•	•	•	•	•									
Door Handle (Upper LH/Btm.RH) (S/O 619574)	S/O																		•	•	•	•	•	•	•	•	
Door Handle (Btm.LH/Upper RH) (S/O 619573)	S/O																		•	•	•	•	•	•	•	•	
Divider, Door Bin Clear (S/O 619008)	S/O																		•	•	•	•					
Freezer Shelf, White (S/O 618650)	S/O								•	•																	
Spring Holder, LH (S/O 619042)	S/O		•	•																							
Spring Holder, RH	64988		•	•																							

*NOTE: The use of generic parts for warranty repairs will void the manufacturer's warranty. Coast Generic Parts are warranted for one year, except Circuit Boards, which are covered for 90 days.

Q

PARTS QUICK REFERENCE

NORCOLD REFRIGERATOR PARTS

In Section Q: Atwood Coleman (RVP) Cooling Units Dometic Norcold Powerhouse Suburban Thetford Wedgewood X-Reference

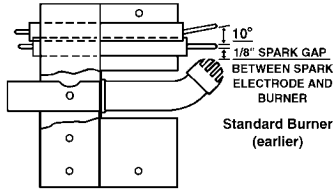

Denotes Limited Supply

MODELS WITH STANDARD BURNER COOLING UNITS

PART DESCRIPTION	ORDER # FOR O.E.M. PART	ORDER # FOR GENERIC PART*	774 EG2	774 EG3	776 EG2	776 EG3	778 EG2	778 EG3	8010 EG2	8010 EG3	838 EG2	838 EG3	8310 EG2	8310 EG3	876 EG2	876 EG3	878 EG2	878 EG3	8662	8663	8682	8683
			COOLING UNITS:																			
Cooling Unit	S/O 6142837	S/O CU327	•	•																		
Cooling Unit (3)	62761				•	•																
Cooling Unit (3) (S/O 61687240)	S/O						•	•			•	•			•	•			•	•		
Cooling Unit (3) (S/O 61687340)	S/O	NLA							•	•			•	•			•	•			•	•
ELEMENTS Watts/Volts:																						
Heat Element 200W/120V (S/O 61470022)	S/O	NLA	•		•																	
Heat Element 200W/120V-150W/12V (S/O 614400)	S/O			•		•																
Heat Element 350W/120V (S/O 61471322)	S/O						•		•		•		•		•		•		•		•	
THERMOSTATS:																						
Gas/Electric (S/O 61437622)	S/O		•	•	•	•	•	•	•													
Electric (S/O 61526222)	S/O										•	•	•	•								
THERMISTERS:																						
Thermister 66" without clip (S/O 61693822)	S/O																		•	•	•	•
Thermister 78" without clip (S/O 61697822)	S/O														•	•	•	•				
Clip only (S/O 61689122)	S/O														•	•	•	•	•	•	•	•
IGNITION MODULE:																						
Relighter w/ground wire (S/O 61746122)	S/O								•	•												
Ignition Control Module (S/O OEM: NOR 61717037MC; GEN: NOR 616972MC)	S/O										•	•	•	•	•	•	•	•	•	•	•	•
CIRCUIT BOARDS:																						
Interface Board (2-way) (S/O 61716822 2-WAY)	(2)	S/O									•	•	•	•								
Interface Board (3-way) (S/O 61716922)	(2)	S/O									•	•	•	•								
Eyeboard Board	(2)										•	•	•	•								
Power Supply Board (2-way) (D-15711 2-way)	S/O																		•		•	
Power Supply Board (3-way)	65052																			•		•
PC Board, Eyeboard (2-way)	NLA																		•		•	
PC Board, Eyeboard (3-way) (S/O 61563922)	S/O																			•		•
PC Board (2-way)	NLA														•		•					
PC Board (3-way) (S/O 61602822)	S/O														•		•					
SWITCHES, EYEBROW:																						
Switch, Black 2-Position	NLA										•	•	•	•								
Switch, Black 3-Position (S/O 61525922)	S/O	64334									•	•	•	•								

*NOTE: The use of generic parts for warranty repairs will void the manufacturer's warranty. Coast Generic Parts are warranted for one year, except Circuit Boards, which are covered for 90 days.

(2) CONTACT NORCOLD SERVICE

NORCOLD REFRIGERATOR PARTS

**PARTS QUICK
REFERENCE**

Q

In Section Q: Atwood Coleman (RVP) Cooling Units Dometic Norcold Powerhouse Suburban Thetford Wedgewood X-Reference

MODELS WITH STANDARD BURNER COOLING UNITS

PART DESCRIPTION	ORDER # FOR O.E.M. PART	ORDER # FOR GENERIC PART*	774 EG2	774 EG3	776 EG2	776 EG3	778 EG2	778 EG3	8010 EG2	8010 EG3	838 EG2	838 EG3	8310 EG2	8310 EG3	876 EG2	876 EG3	878 EG2	878 EG3	8662	8663	8682	8683
SWITCHES, DIVIDER:																						
Switch, Light (S/O 61581022)	S/O										•	•	•	•	•	•	•	•	•	•	•	•
Switch, Black 2-position	NLA										•	•	•	•								
Switch, Black 3-Position (S/O 61525922)	S/O	64334									•	•	•	•	•	•	•	•				
Rocker Switch, Black (S/O 61594322)	S/O																		•	•	•	•
Switch 3-way (AC/DC) (S/O 61439122)	S/O								•													
SWITCHES, BASE:																						
Switch 3-way (AC/DC) (S/O 61439122)	S/O			•		•		•														
THERMOCOUPLES:																						
Thermocouple (61436322)	S/O		•	•	•	•	•	•														
Thermocouple (S/O 61483322)	S/O								•	•												
SAFETY VALVE:																						
Safety Valve (S/O 614377)	S/O		•	•	•	•	•	•	•	•												
SOLENOID VALVES:																						
Fenwal Valve, (NLA) use ASCO Valve kit (S/O 61630090)	S/O								•	•	•	•	•	•								
Solenoid Valve (ASCO) (S/O 61551822)	S/O								•	•	•	•	•	•	•	•	•	•	•	•	•	•
BURNER ASSEMBLIES:																						
Burner Assy, No Electrode (S/O 61452022)	S/O				•	•																
Burner Electrode Assy. (S/O 61464037)	S/O		•	•																		
Burner Electrode Assy. (S/O 61516437)	S/O						•	•	•	•												
Burner Assy, No Electrodes (S/O 61537022)	S/O										•	•	•	•	•	•	•	•	•	•	•	•
ORIFICES:																						
Orifice (0.14) without gasket S/O 618866	S/O		•	•	•	•																
Orifice (0.16) without gasket (S/O 628003)	S/O						•	•	•	•	•	•	•	•	•	•	•	•	•	•	•	•
Gasket only	62772		•	•	•	•	•	•	•	•	•	•	•	•	•	•	•	•	•	•	•	•
ELECTRODES:																						
Ignition Electrode (S/O 61524722)	S/O		•	•	•	•	•	•	•	•	•	•	•	•	•	•	•	•	•	•	•	•
Sensor Electrode (S/O 61524822)	S/O										•	•	•	•	•	•	•	•	•	•	•	•
Miscellaneous Parts:																						
Middle Travel Lock	NLA		•	•	•	•	•	•	•	•	•	•	•	•								
Swing Latch Assy.	NLA														•	•	•	•				
End Cap (Black) Spring Catch (3)	62701																			•	•	•
End Cap (Black) Stop (3)	62703																			•	•	•
Spring, Door Handle	62555																			•	•	•
Upper Door Handle Assy, (Blk) (3) (S/O 61592938)	S/O																			•	•	•
Lower Door Handle Assy, (Blk) (3) (S/O 61648838)	S/O																				•	•
Lower Door Handle Assy, (Blk) (3) (S/O 61593038)	S/O																			•	•	•
Door Latch	62625																			•	•	•

*NOTE: The use of generic parts for warranty repairs will void the manufacturer's warranty.
Coast Generic Parts are warranted for one year, except Circuit Boards, which are covered for 90 days.

(2) CONTACT NORCOLD SERVICE

(3) Brown, NLA

MODELS WITH STANDARD BURNER COOLING UNITS

PART DESCRIPTION	ORDER # FOR O.E.M. PART	ORDER # FOR GENERIC PART*	776 EG2	776 EG3	778 EG2	778 EG3	838 EG2	838 EG3	876 EG2	876 EG3	8662	8663	8010 EG2	8010 EG3	8310 EG2	8310 EG3	878 EG2	878 EG3	8682	8683	
COOLING UNITS:																					
Cooling Unit	62761		•	•																	
Cooling Unit (S/O 61687240)	S/O				•	•	•	•	•	•	•	•									
Cooling Unit (S/O 61687340)	S/O												•	•	•	•	•	•	•	•	•
BURNER CONVERSION KITS:																					
Conversion Kit	NLA						•		•		•									•	
Conversion Kit	NLA							•		•		•									•
Conversion Kit	NLA												•								
Conversion Kit (S/O NSC0053)	S/O													•							
Conversion Kit (S/O NSC0054)	S/O				•																
Conversion Kit (S/O NSC0055)	S/O					•															
Conversion Kit (S/O NSC0056)	S/O		•																		
Conversion Kit (S/O NSC0057)	S/O			•																	

*NOTE: The use of generic parts for warranty repairs will void the manufacturer's warranty. Coast Generic Parts are warranted for one year, except Circuit Boards, which are covered for 90 days.

Using the refrigerator model, locate the correct Cooling Unit and Burner Conversion Kit needed to replace the defective Cooling Unit.

NOTE: When replacing a Standard Burner Cooling Unit with a Horizontal Burner Cooling Unit, a Burner Conversion Kit is required!